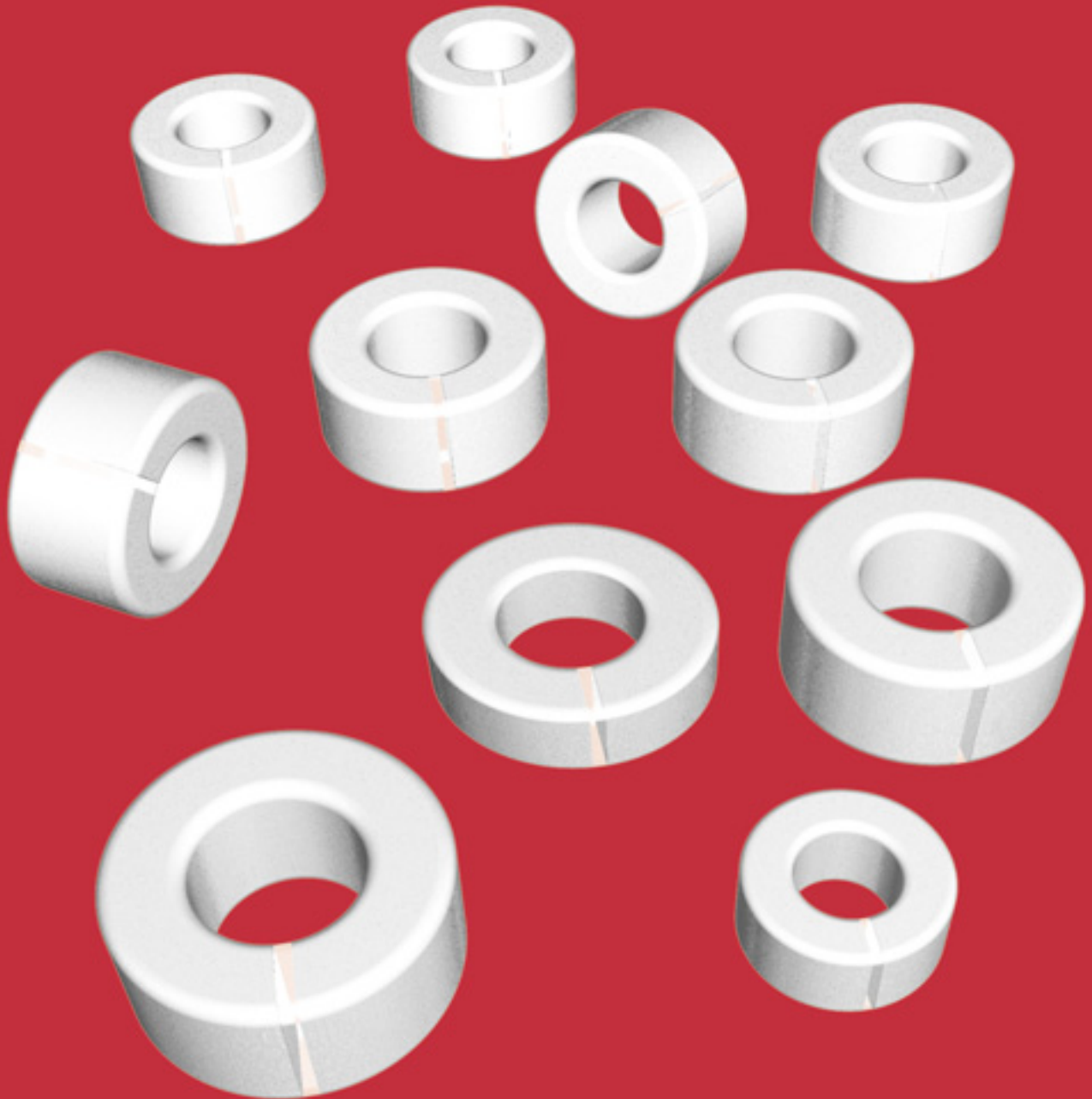
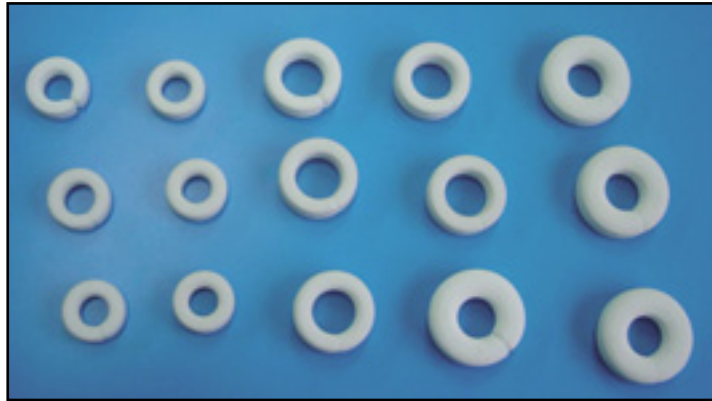


Gapped ferrite toroids for power inductors





Gapped ferrite toroids for power inductors

Contents

Introduction	1
Features	1
Applications	1
Type number structure	1
Product range and specifications	2
A_L versus DC bias curves	3
Influence of winding position	6
P_v versus temperature curves	6
Comparison with metal powder cores	7
I^2L versus A_L curves	10
Product performance calculation	11
Example	11
Note on power loss measurement	12

Introduction

Toroids are well known for their magnetic properties. They achieve the highest inductance per unit of volume due to the uniform cross-section and a fluent magnetic path without corners. The latter means that not only the cross-section, but also the flux density is uniform, which is especially important to fully exploit the material saturation level. Also stray flux is very low for a toroid.

FERROXCUBE has introduced a range of gapped ferrite toroids, intended primarily for power inductor applications. They are made from toroids in the high flux, frequency stable material 3C20 by precision machining a small gap. Finally, the core is completely coated with nylon and ready for winding as if it were ungapped.

The gap helps to avoid saturation in applications where there is a large current. This can be either a DC bias current or an AC current swing. For every size of toroid there is a range of gaps, providing a range of A_L values to fit the required inductance value. The high flux, frequency stable

material 3C20 has very low power losses, outperforming in this respect iron powder and all metal alloy powders. Even if a slightly larger core is required, ferrite could beat certain metal alloys on price.

Features

- Simple economic shape
- Available in high flux, frequency stable material 3C20
- Range of toroid sizes and A_L values
- Compact and robust product

Applications

These products will mainly be found as power inductors. These carry larger currents and a gap is required to avoid saturation. There are many types of power inductors, in accordance with many types of power converters :

- Output filter inductor in forward or push-pull converter (DC bias)
- Resonant inductor in half or full bridge converter (AC swing)
- Buck or boost inductor in DC voltage converter (DC bias)
- Power factor correction choke (AC bias)
- Differential filter inductor (DC or AC bias)

A possible application is also a fly-back transformer. For practical reasons, it is often difficult however to realize with a toroid. There can be more than one output winding and the electrical isolation between primary and secondary side must guarantee a distance of separation.

Type number structure

Gapped toroids can be named quite easily.

The general type number structure is explained in figure 1 below.

The inner diameter is determined by the outer diameter, because only standard toroid sizes are used that already exist without gap. In such a way, all too long type numbers are avoided when the toroid is gapped.

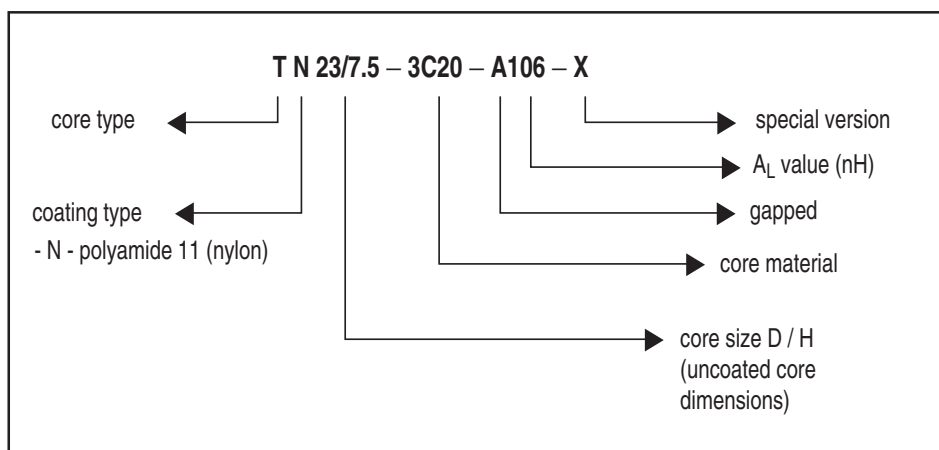
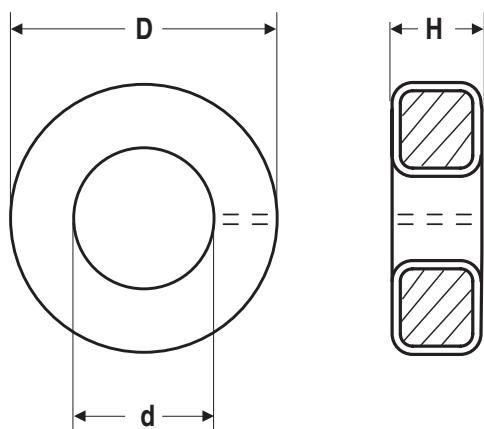


Fig. 1 : Type number structure

Product range and specifications



Core type	B (mT) at	Core loss (W) at	
	H = 1200 A/m f = 10 kHz T = 100 °C	f = 100 kHz B = 100 mT T = 100 °C	f = 100 kHz B = 200 mT T = 100 °C
TN10/6/4	≈ 400	≤ 0.017	≤ 0.11
TN13/7.5/5		≤ 0.033	≤ 0.22
TN17/11/6.4		≤ 0.070	≤ 0.47
TN20/10/6.4		≤ 0.12	≤ 0.80
TN23/14/7.5		≤ 0.16	≤ 1.1
TN26/15/11		≤ 0.33	≤ 2.2

Core type	dimensions (mm)			effective core parameters					
	outside diameter D (mm)	inside diameter d (mm)	height H (mm)	core factor $\Sigma I/A$ (mm ⁻¹)	effective volume V_e (mm ³)	effective length l_e (mm)	effective area A_e (mm ²)	mass (g)	isolation voltage (V)
TN10/6/4	10.6 ± 0.3	5.2 ± 0.3	4.4 ± 0.3	3.07	188	24.1	7.8	≈ 0.95	1000
TN13/7.5/5	13 ± 0.35	6.6 ± 0.35	5.4 ± 0.3	2.46	368	30.1	12.2	≈ 1.8	1500
TN17/11/6.4	17.5 ± 0.5	9.9 ± 0.5	6.85 ± 0.35	2.24	787	42.0	18.7	≈ 3.7	1500
TN20/10/6.4	20.6 ± 0.6	9.2 ± 0.4	6.85 ± 0.35	1.43	1330	43.6	30.5	≈ 6.9	2000
TN23/14/7.5	24.0 ± 0.7	13.0 ± 0.6	8.1 ± 0.45	1.69	1845	55.8	33.1	≈ 9.0	2000
TN26/15/11	26.8 ± 0.7	13.5 ± 0.6	11.6 ± 0.5	0.982	3700	60.1	61.5	≈ 19	2000

The cores are coated with polyamide II (PAII), flame retardant in accordance with “UL94V-2”, UL file number E 45228 (M). The inner and outer diameters apply to the coated toroid.

Contacts are applied on the edge of the toroid for isolation voltage test, which is also the critical point for the winding operation.

Core type	A_L (nH)	$\mu\epsilon$
TN10/4-3C20-A48	48 ± 15 %	90
TN10/4-3C20-A66	66 ± 15 %	125
TN10/4-3C20-A78	78 ± 15 %	147
TN10/4-3C20-A84	84 ± 15 %	160
TN10/4-3C20-A92	92 ± 15 %	173

Core type	A_L (nH)	$\mu\epsilon$
TN17/6.4-3C20-A52	52 ± 15 %	90
TN17/6.4-3C20-A72	72 ± 15 %	125
TN17/6.4-3C20-A88	88 ± 15 %	147
TN17/6.4-3C20-A92	92 ± 15 %	160
TN17/6.4-3C20-A104	104 ± 15 %	173

Core type	A_L (nH)	$\mu\epsilon$
TN23/7.5-3C20-A65	65 ± 15 %	90
TN23/7.5-3C20-A90	90 ± 15 %	125
TN23/7.5-3C20-A106	106 ± 15 %	147
TN23/7.5-3C20-A115	115 ± 15 %	160
TN23/7.5-3C20-A124	124 ± 15 %	173

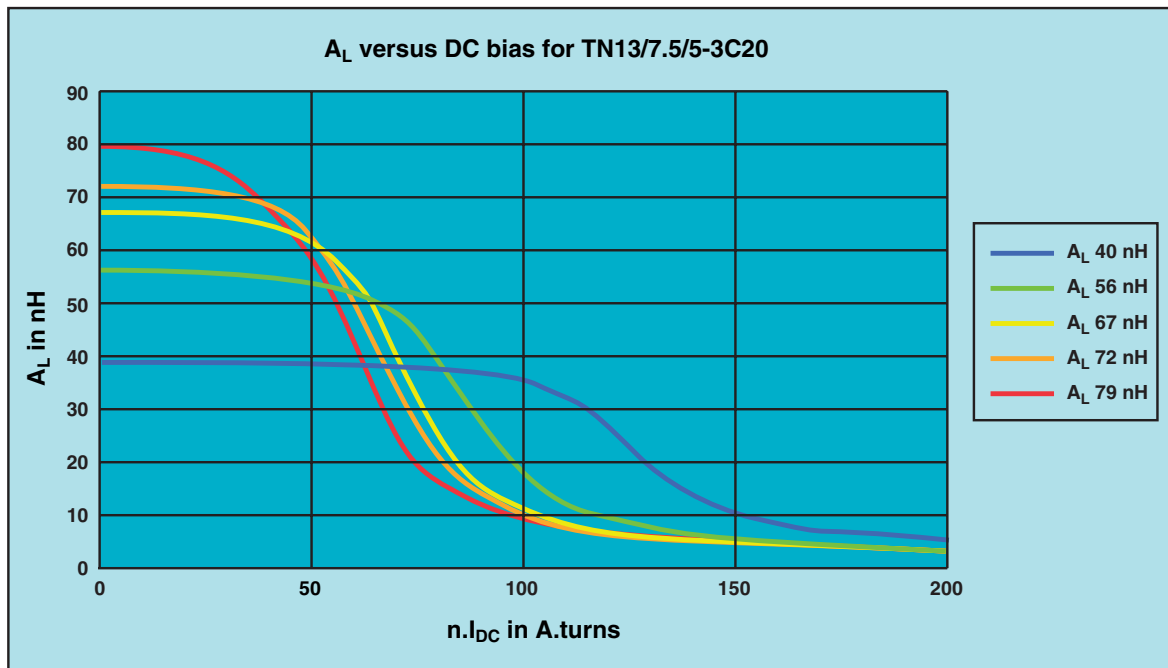
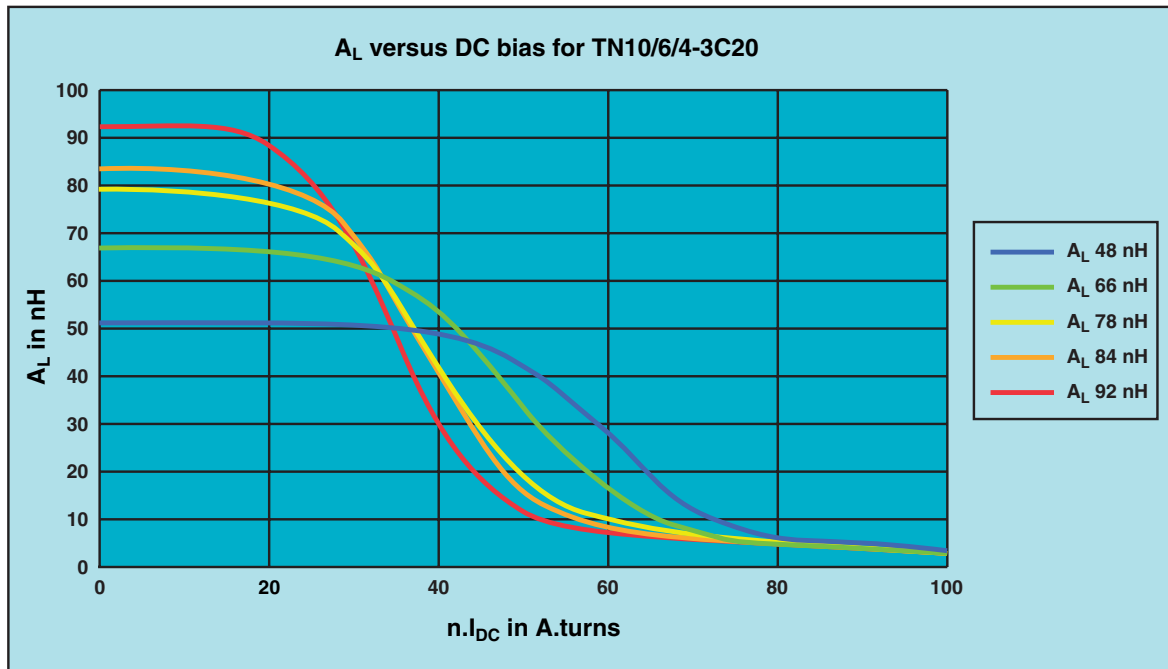
Core type	A_L (nH)	$\mu\epsilon$
TN13/5-3C20-A40	40 ± 15 %	90
TN13/5-3C20-A56	56 ± 15 %	125
TN13/5-3C20-A67	67 ± 15 %	147
TN13/5-3C20-A72	72 ± 15 %	160
TN13/5-3C20-A79	79 ± 15 %	173

Core type	A_L (nH)	$\mu\epsilon$
TN20/6.4-3C20-A68	68 ± 15 %	125
TN20/6.4-3C20-A81	81 ± 15 %	147
TN20/6.4-3C20-A87	87 ± 15 %	160
TN20/6.4-3C20-A96	96 ± 15 %	173
TN20/6.4-3C20-A109	109 ± 15 %	200

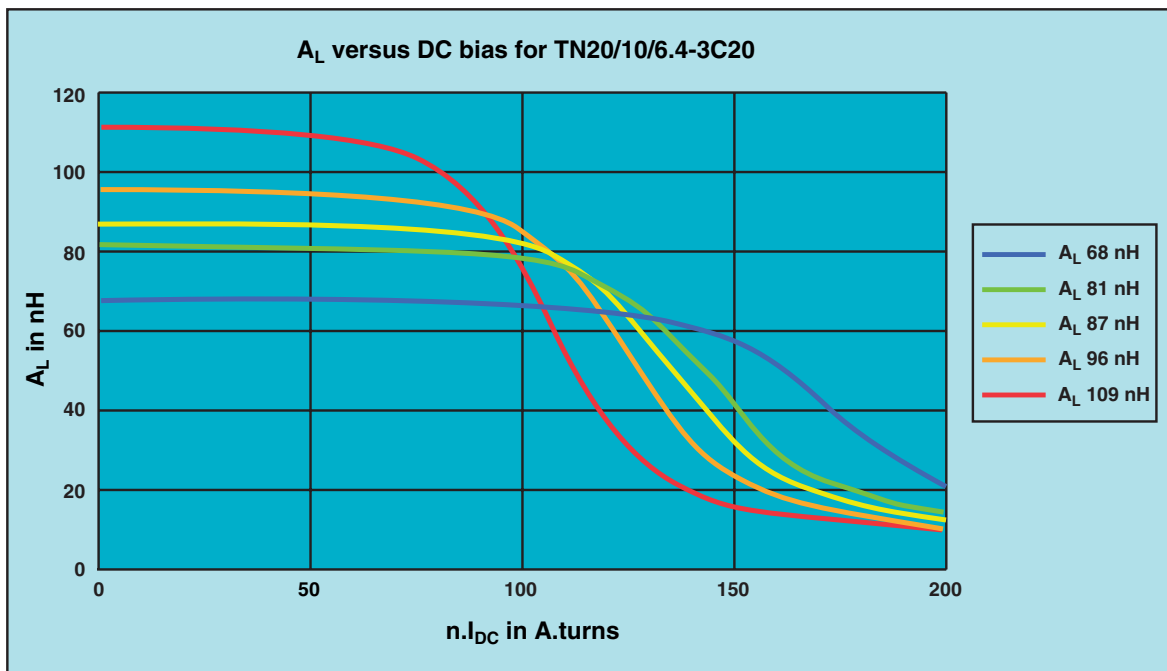
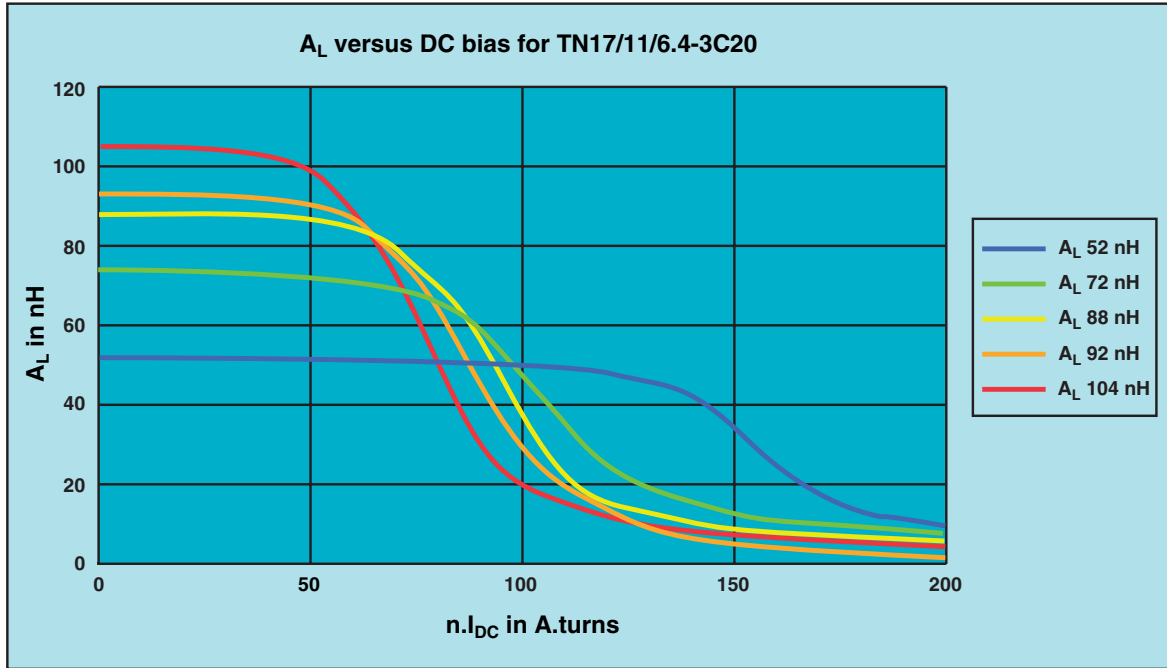
Core type	A_L (nH)	$\mu\epsilon$
TN26/11-3C20-A113	113 ± 15 %	90
TN26/11-3C20-A157	157 ± 15 %	125
TN26/11-3C20-A185	185 ± 15 %	147
TN26/11-3C20-A201	201 ± 15 %	160
TN26/11-3C20-A217	217 ± 15 %	173

A_L versus DC bias curves

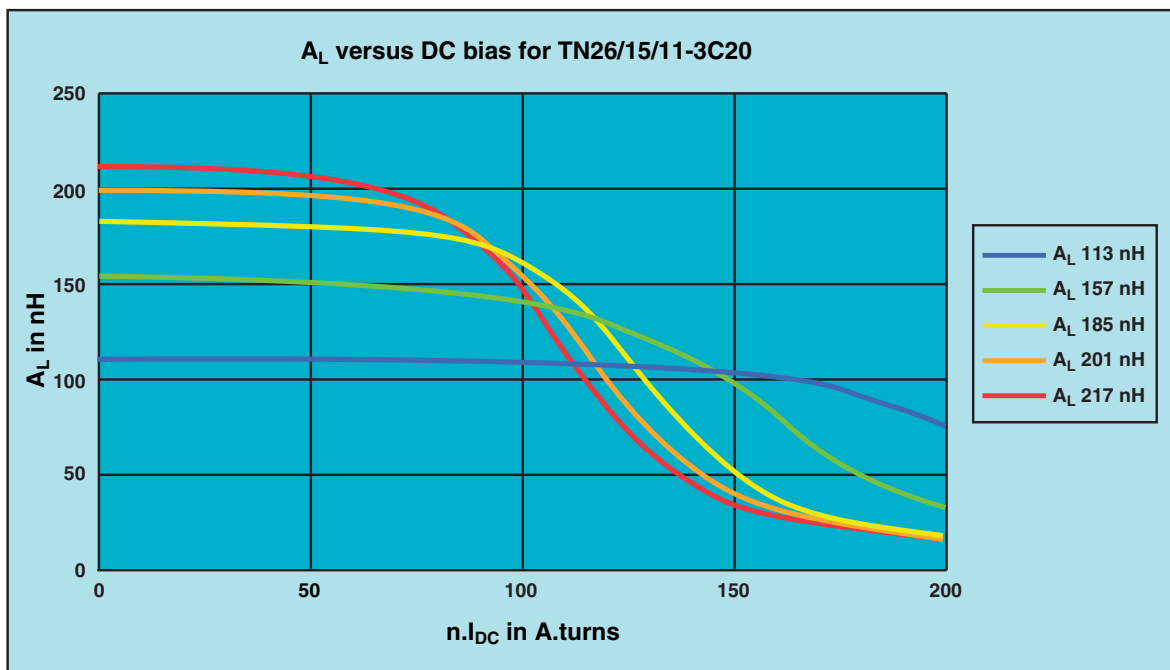
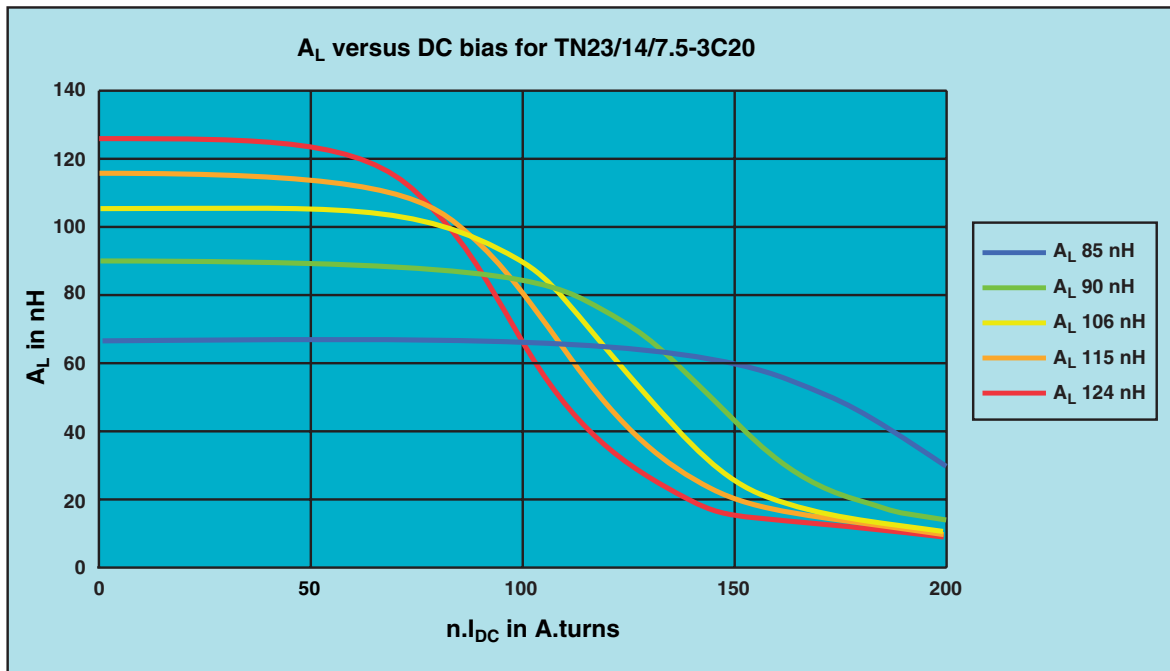
These curves show the stability of A_L versus DC bias current. The saturating field H_{DC} depends on the number of Ampere-turns ($H_{DC} = n \cdot I_{DC} / l_e$). The lower the A_L value, the larger the gap and the more DC bias capability the toroid shows.



A_L versus DC bias curves (continued)



A_L versus DC bias curves (continued)



Influence of winding position

All curves above are for a winding, evenly distributed over the circumference of the toroid. The place of the winding has considerable influence on induction. Non-biased induction is maximum when the winding is placed opposite to the gap. This is due to the increase of stray flux compared to a distributed winding. The decrease of inductance with DC bias will be faster, however. The reverse effect occurs with a winding on the gap. Inductance and stray flux are minimized.



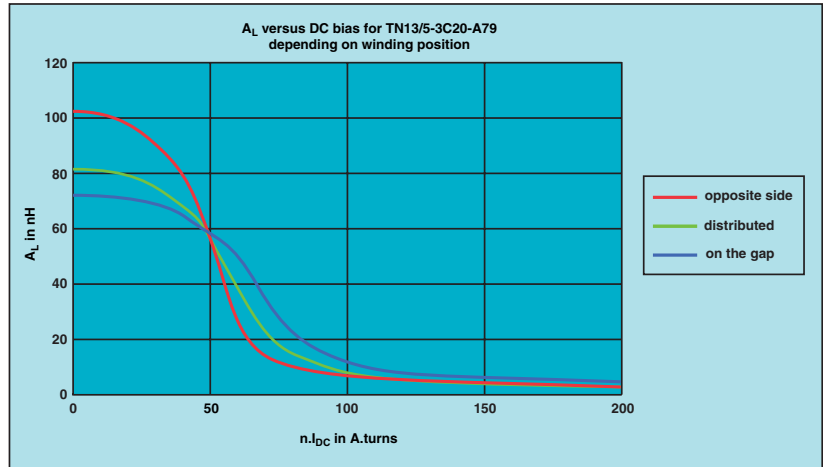
Fig. 2a : Distributed



Fig. 2b : Opposite side

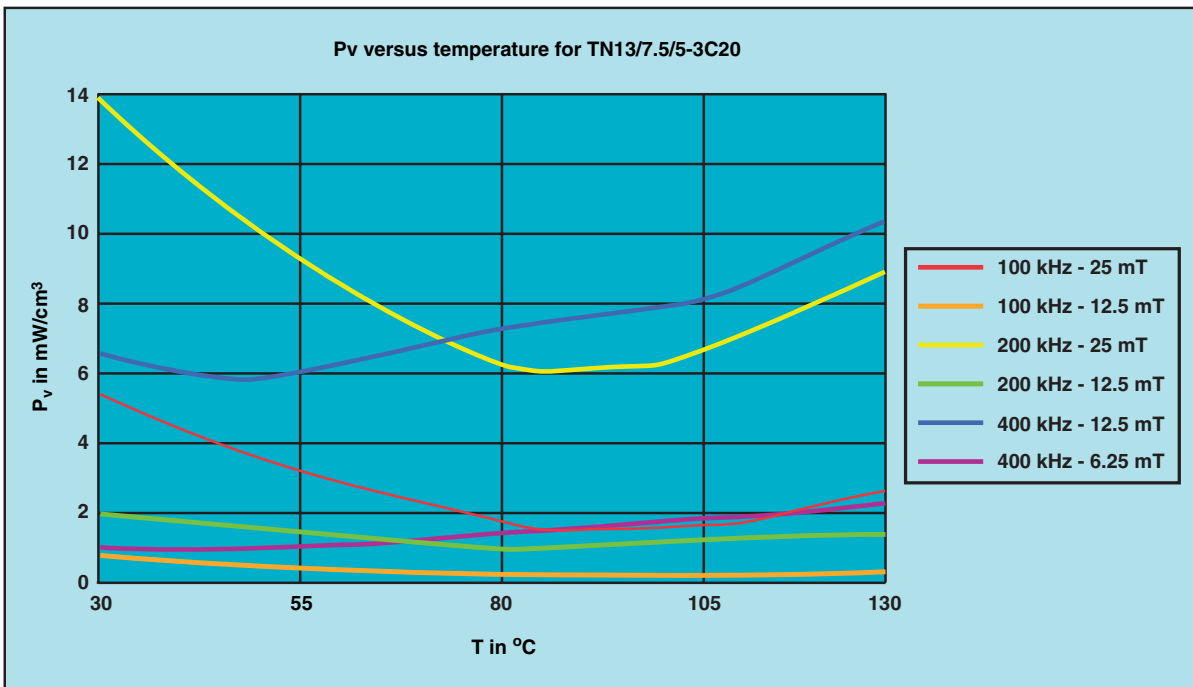


Fig. 2c : On the gap



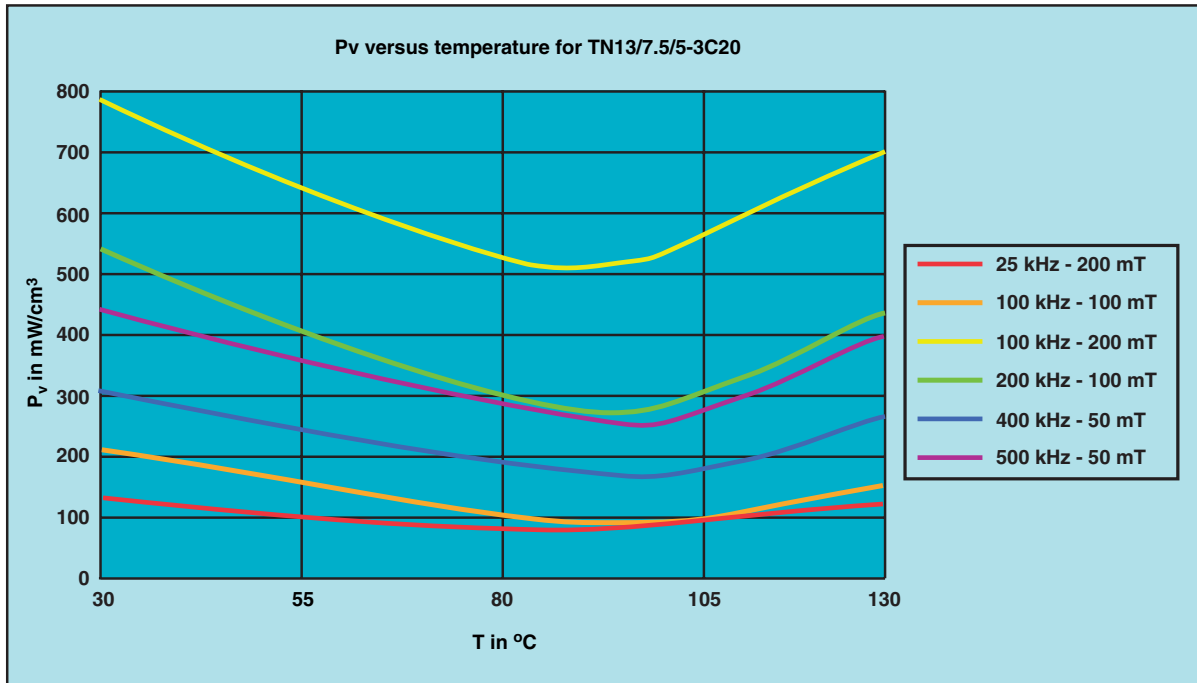
P_v versus temperature curves

These curves give the loss per unit of volume, how it varies with temperature, depending on frequency and flux density. There is a minimum value, defining the optimum working temperature.



P_v versus temperature curves (continued)

P_v measured on ungapped toroids (this is practice for paired core shapes) because of measurement accuracy and amplifier load, see note on page 12. The same loss density curves apply to all A_L values and core sizes.



Comparison with metal powder cores

Several other material categories are used for power inductors. Metal powders form an important group. The metal can be pure iron or an alloy. In the form of a powder they have a distributed gap and don't need to be gapped as a core.

- Pure iron
Composition : Fe 100 %
Permeability : up to 90
Highest saturation flux density
- Molybdenum Permalloy Powder (MPP)
Composition : Ni 80 % – Fe 20 %, some substitution by Mo
Permeability : up to 550 (because of the high intrinsic permeability of permalloy)
Power loss volume density closest to ferrite

- High Flux
Composition : Ni 50 % – Fe 50 %
Permeability : up to 160
Highest saturation flux density of metal alloys
- Sendust (sold under various brand names)
Composition : Fe 85 % – Si 10 % – Al 5 %
Permeability : up to 125
Saturation flux density & power loss volume density intermediate

Ferrite comes into the picture where the limiting condition is power loss rather than saturation, so especially for high frequency and also for resonant inductors (large AC swing). For a certain set of application conditions, the limiting condition for metal powder can well be the power loss,

while for ferrite it is the saturation. Even if that leads to a slightly larger core size, the gapped ferrite toroid could be more economical than expensive materials like MPP or high flux.

3C20 has an improved saturation level which makes it well-suited as an inductor material.

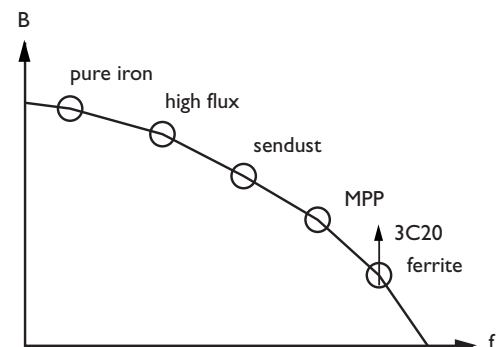
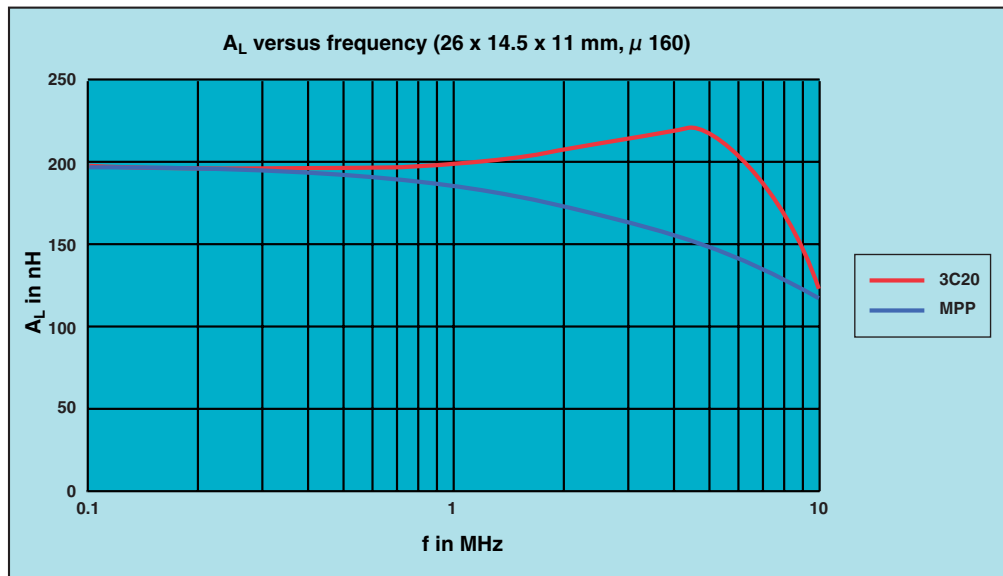


Fig. 3 : Relative position of materials

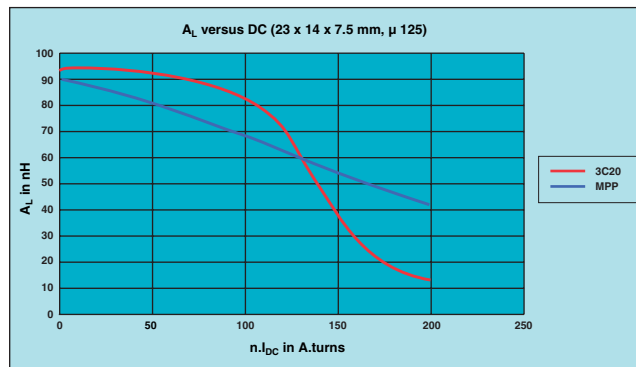
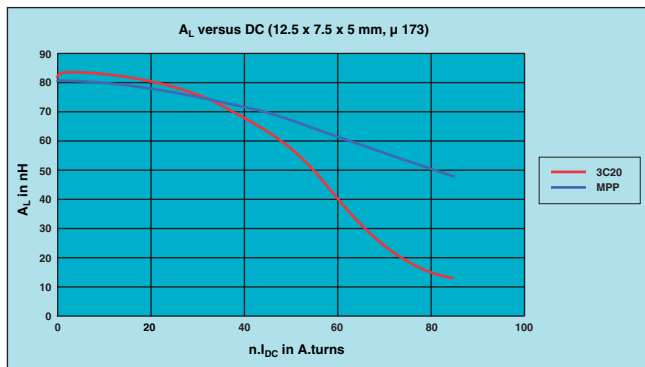
Pure iron, high flux and sendust have a soft saturation curve due to the distributed gap. The permeability starts dropping early, but the slope doesn't increase fast. MPP has a much more abrupt saturation curve due to the very high intrinsic permeability of permalloy. The hysteresis loop is therefore extremely sheared.

Ferrite toroids have a single gap and the fringing effect compensates the slow intrinsic permeability drop until real saturation occurs. The stability with frequency is better for gapped ferrite, which is an advantage if linearity is a requirement, e.g. in class D audio amplifiers.

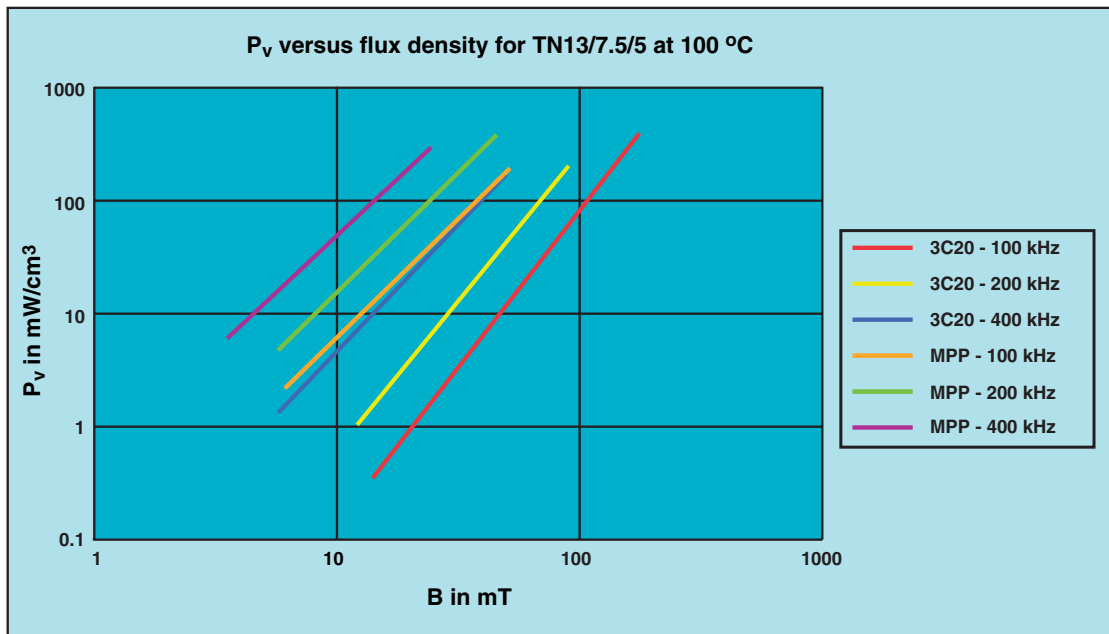
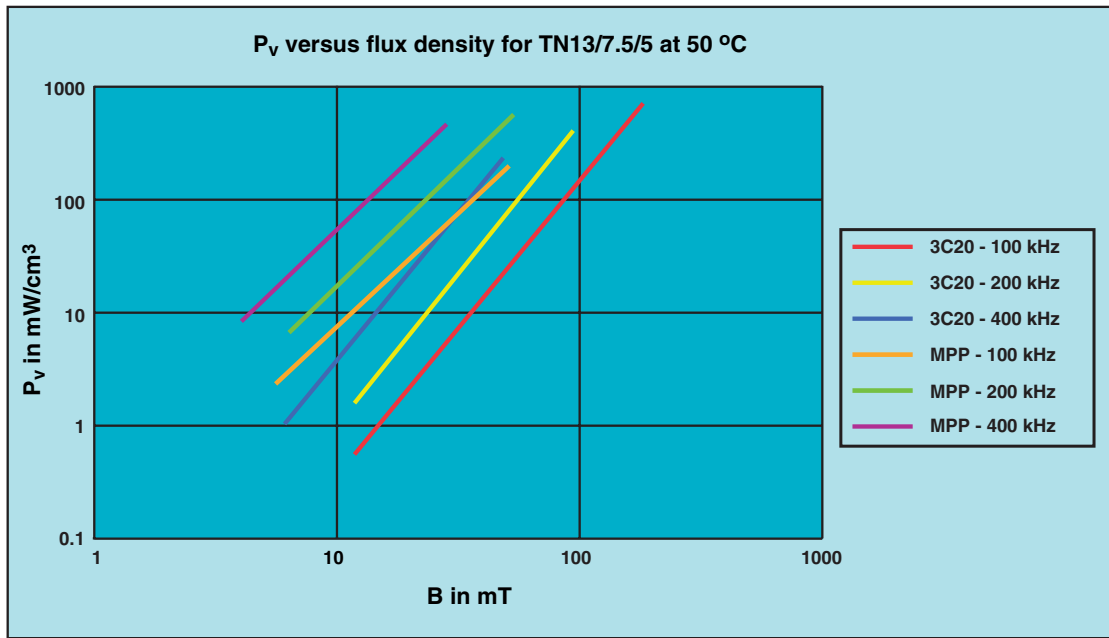
In the following graph we can see a comparison between a gapped ferrite toroid (TN26/11-3C20-A201) and a powder core (MPP, 26.9x14.7x11.2mm, A201). We can see the frequency behavior of the different pieces. The stability with frequency is still better for gapped ferrite than for MPP.



Below 2 graphs comparing the saturation behaviour between a gapped ferrite toroid (TN13/5-3C20-A79) and a powder core (MPP, 12.7x7.6x4.8 mm, A79) for the first graph and TN23/7.5-3C20-A90 and MPP, 22.9 x 14 x 7.6, A90 for the second. For not too high current, the stability is better for gapped ferrite. For the highest currents however, saturation flux density prevails.

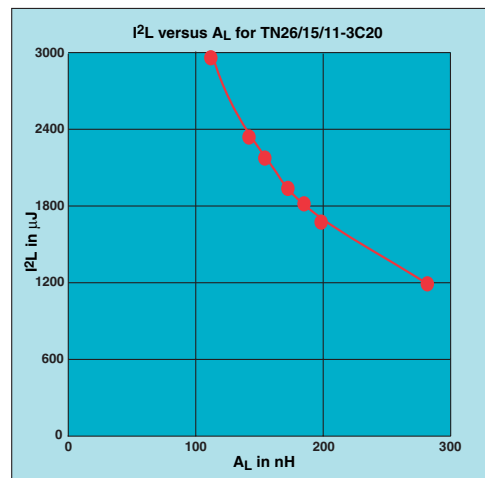
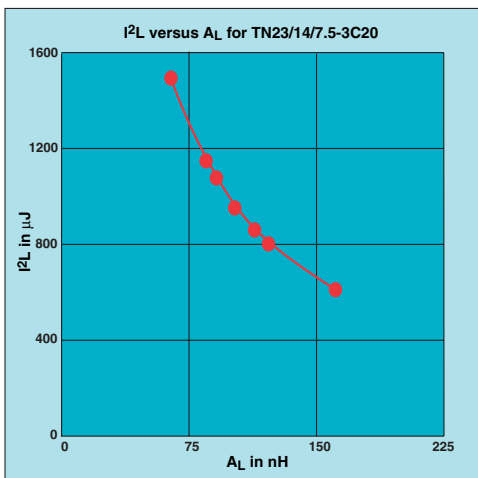
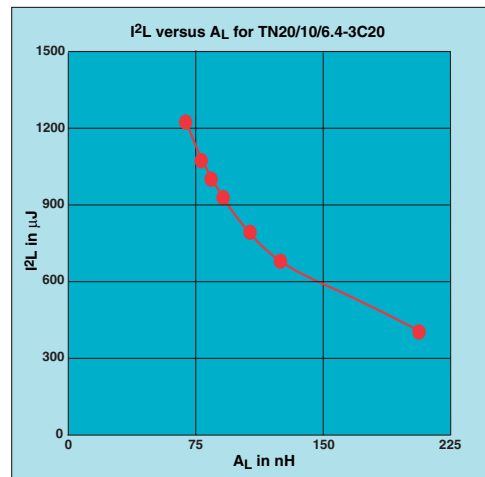
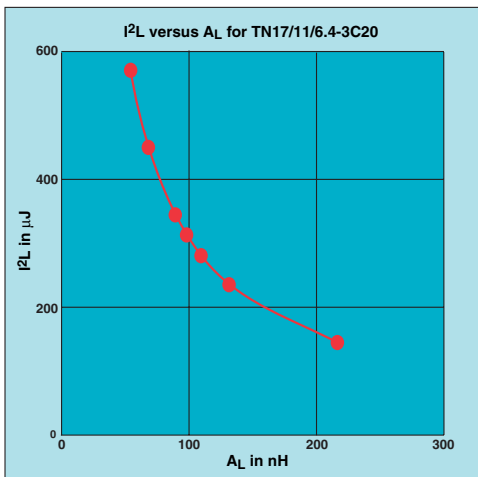
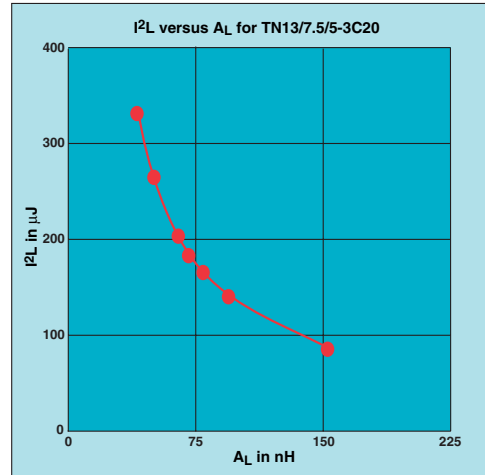
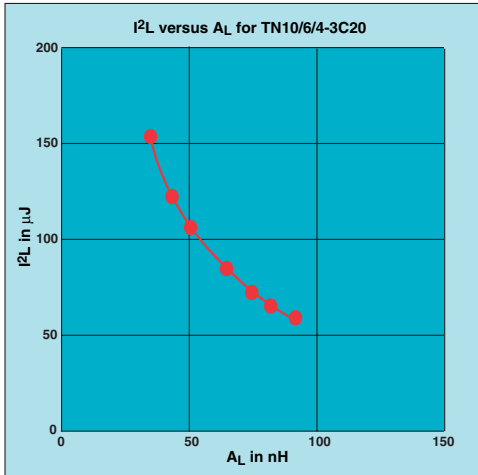


Finally 2 graphs comparing the core losses of a gapped ferrite toroid (TN13/7.5/5-3C20) and a powder core (MPP, 12.7 x 7.6 x 4.8 mm), at 50 and 100 °C. The difference is at least a full decade, showing that where losses are premium, ferrite is the best material choice.



I^2L versus A_L curves

These curves give the maximum energy storage value, depending on A_L value. The larger A_L , the smaller the gap and the lower the energy value, which is used to calculate the minimum toroid size for an output inductor. There are more sizes and A_L values available and custom products can be made upon request.



Product performance calculation

With the aid of the foregoing I^2L graphs, the minimum required core size can be calculated. The loss graphs serve to determine the total core loss.

- The required inductance (at maximum load) and the maximum load current determine the energy storage :
 $E_{\min} = I_{\text{load}}^2 \cdot L_{\min}$
- The minimum energy storage determines the minimum core size and the maximum A_L value of the core. Choose a core size of which the corresponding I^2L graph reaches the required minimum of energy storage E_{\min} . Choose an A_L value in the graph that reaches this level.
- The required inductance determines the number of turns : $n = \sqrt{L_{\min}/A_L}$
This is rounded to an entire number.
- Voltage and frequency determine the flux density
for sinusoidal flux and voltage variation : $B_{\max} = V_{\text{rms}}/(\sqrt{2} \cdot \pi \cdot n \cdot f \cdot A_e)$, $V_{\text{rms}} = V_{\max}/\sqrt{2}$
for triangular flux and rectangular voltage variation : $B_{\max} = V_{\text{rms}}/(4 \cdot n \cdot f \cdot A_e)$, $V_{\text{rms}} = V_{\max}$
- Core loss follows from flux density and frequency : $P = P_v(B_{\max}, f) \cdot V_e$

Example

Required : output choke with inductance $> 5 \mu\text{H}$ at a maximum load current 15 A.

The minimum energy storage $E_{\min} = 15^2 \cdot (5 \times 10^{-6}) = 1125 \mu\text{J}$.

The smallest toroid reaching this level is TN20/6.4, where only $A_L = 68 \text{ nH}$ exceeds this level.

The number of turns is now $n = \sqrt{(5000/68)} = 8.6 \rightarrow 9$ turns $\rightarrow n \cdot I_{\text{load}} = 135 \text{ A} \cdot \text{turns}$.

In the A_L vs. DC bias graph of TN20/6.4 one can check that no significant saturation occurs.

A_L value 109 nH could reduce the turns to 7 to achieve 5 μH , but would not comply with 15 A load.

Suppose the choke is driven by a rectangular voltage of 4 V amplitude, switching at 200 kHz.

Taking into account the core effective cross-section 30.5 mm² of TN20/6.4, peak flux density will be :

$$B_{\max} = 4 / (4 \cdot 9 \cdot 200 \times 10^3 \cdot 30.5 \times 10^{-6}) = 18.2 \text{ mT}.$$

Ignoring the influence of bias current and non-sinusoidal waveforms,

the graphs of $P_v(T)$ can be taken as reference.

Even for lower temperatures the loss density will be below 10 mW/cm³.

With an effective volume of 1.33 cm³, the core loss will only be in the order of 10 mW.

Remark

An output choke can also carry a large AC current instead of a small ripple current and a large DC bias current. This is the case in output filters of audio amplifiers.

For detailed design information, see our brochure :

9930 030 0001 I, Class D audio amplifier with Ferroxcube gapped toroid output filter.

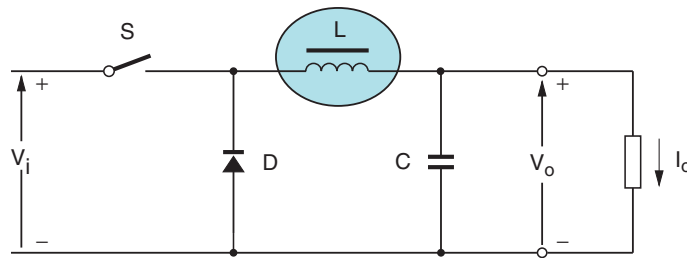


Fig. 4 : Output inductor in forward configuration.

Note on power loss measurement

Power losses as presented in this brochure have been measured on ungapped ferrite toroids, as is common practice for paired core shapes like EFD etc. Gapped cores have a much lower loss tangent $tg\delta$ which reduces the loss measurement accuracy and increases the amplifier load :

- Lower loss tangent

$$(tg\delta/\mu)_e = tg\delta/\mu$$

$$tg\delta_e/\mu_e = tg\delta/\mu$$

$$tg\delta_e = (\mu_e/\mu).tg\delta$$

As $\mu_e/\mu < 1$, the loss tangent is reduced by a gap.

- Lower measurement accuracy

$$P = V.I.\cos\varphi = V.I.\sin\delta$$

$$dP/d\delta = V.I.\cos\delta$$

$$\Delta P/P = (dP/d\delta).\Delta\delta/P = \Delta\delta/tg\delta = 2\pi.f.\Delta t/tg\delta$$

μ = permeability without gap
 $tg\delta$ = loss tangent without gap
 $tg\delta/\mu$ = loss factor without gap
 μ_e = permeability with gap
 $tg\delta_e$ = loss tangent with gap
 $(tg\delta/\mu)_e$ = loss factor with gap



Fig. 5 : SAMPLEBOX15 - 4330 032 22151

For a given time accuracy Δt (equipment), the relative loss error $\Delta P/P$ increases proportional with frequency f and inversely proportional with loss tangent $tg\delta$ (or proportional to quality factor Q).

The above linear calculation holds for small signals, but qualitatively the result is the same for large signals and hysteresis loops.

Measuring with the same flux density B still leads to the same power loss P as for gapped ferrite toroids, apart from the core volume factor $V_g/V_e = (A_e.(l_e-l_g))/(A_e.l_e) = 1-l_g/l_e \approx 1$. Another deviation is the influence of stray flux, which also depends on the place of the winding. In the above calculation, the flux is supposed to cross the gap straight. Measuring on a gapped core has a second problem, apart from the loss of accuracy. Low effective permeability (compared to a non-gapped toroid) means low inductance and high load current. After all, the voltage has to be the same as for a non-gapped toroid to keep the same flux density B .

In the case of metal powder cores, it's impossible to measure without the (distributed) gap, but the accuracy is much higher due to the higher loss tangent $tg\delta$.